

Miniskimmer Montageanleitung und Ersatzteilliste

P007A Blende

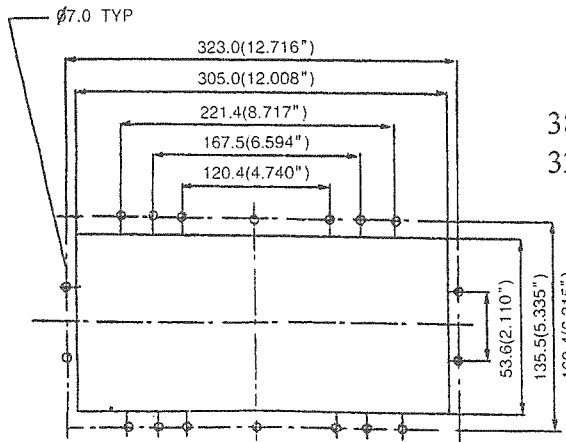

Flanschmaße



P015 Skimmerdeckel

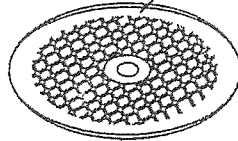

P012 Bodenabsaugplatte

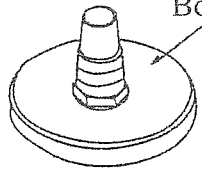

P016 Korb mit Bügel

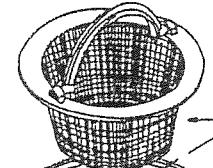

P017 Skimmerklappe

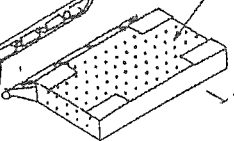

P011 Schlauchtülle für Skimmer

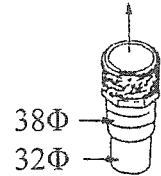

P021 Kontermutter



P010 Dichtungen

P019 Grundelement für Einlaufdüse

P004 Einlaufdüse komplett

P005 Kugel und Überwurfmutter

P022 Halterung für Kugel

P018 Konkavdichtung für Breitmaulskimmer

P003 Breitmaulskimmer -Set

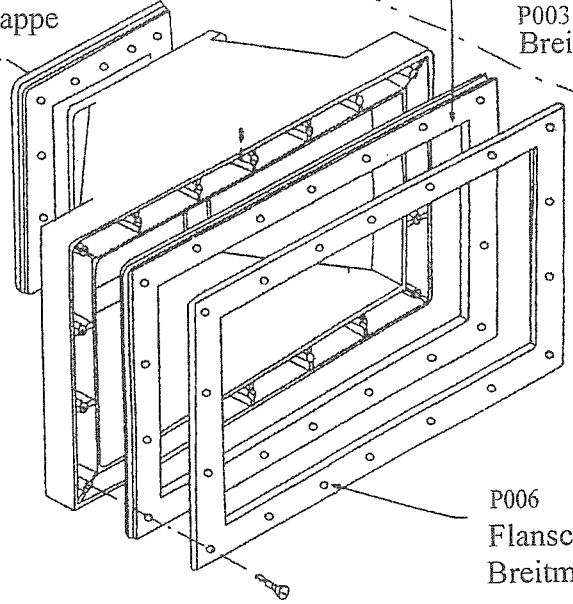

Miniskimmer-Set

P002 Schrauben-Set für Breitmaulskimmer

P006 Flansch für Breitmaulskimmer