



► LED SPOTLIGHT FOR ABOVE GROUND POOLS



T° MAX. WATER 	CONSUMPTION 8W	ROHS COMPLIANT 
LIFESPAN L70B50 50.000h	NO REGULABLE 	RATED VOLTAGE LAMP+DRIVER 230Vac 50/60Hz

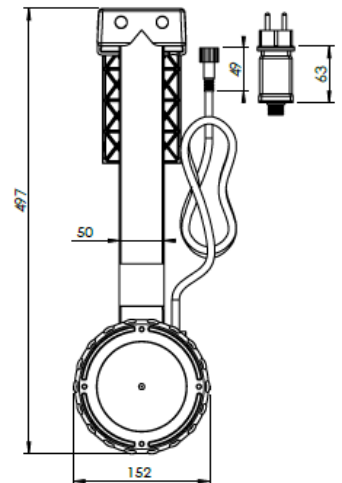
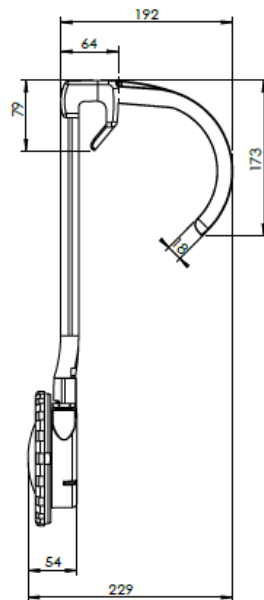

PRODUCT DESCRIPTION

LED projector that has been designed to be used in above-ground pools. Includes a 7 meter cable and driver to be directly connected to a 220 –240 VAC outlet.

It has three types of fastening for above-ground pools:

- Standard fastening
- Beach fastening "Playa"
- Fastening with hook

To be used only underwater.

ACCESSORIES INCLUDED IN THE PACK:

- 220-240 VAC connector driver.
- 7 m. cable.
- 3 fastening systems for different types of pools.
- Installation and maintenance manual.

► **CARACTERÍSTICAS TÉCNICAS / TECHNICAL CHARACTERISTICS**

CARACTERÍSTICAS / CHARACTERISTICS	
Code	74864
Light color	White
Color temperature	5.700 °K
Energy efficiency	
Consumption	8 W
Rated voltage	220-240 Vac 50/60 Hz (projector + driver)
Luminous flux	880 lm
Cable	H05RN-F 7m 2x1 mm ²
Protection	Clase III IP68 2m (projector)

► **LOGÍSTICA / LOGISTICS**

EMBALAJE Y PALETIZADO / PALLETIZED AND PACKAGING	
Box size (mm)	650 x 165 x 95
Units / Box	1
Volume / Box (m ³)	0,010
Weight / Box (kg)	1,63
Standard box sizes (mm)	660 x 340 x 220
Units / Standard box	4
Volume / Standard box (m ³)	0,049
Weight / Standard box (kg)	6,72
Pallet sizes (mm)	800 x 1200 x 2350
Units / Pallet	120
Volume / Pallet (m ³)	2,256
Weight / Pallet (kg)	293,8

► **LABEL**



► **BOX**

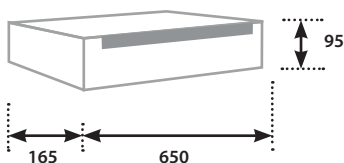

► **STANDARD BOX**

